

8112P180-60



Table of Contents

For Future Assistance	1
Safety Instructions	2-3
Controls at a Glance	4-6
Function Pads	4-5
Setting the Clock	5
Setting the Timers	5-6
Oven Control Lockout	6
Adjusting Oven Temperature	7
Oven Vent @ Light	7
Oven Operation	8-16
Baking, Roasting and Convection Cooking	8
Oven Fans	8
Convenience Foods	9
Oven Racks and Positions	9
Baking Chart	10
Probe	11
Broiling	12
Clock Controlled	
Oven Operations	13-14
Drying	15-16
Care and Cleaning	17-20
Self-Clean Oven	17-18
Cleaning Chart	19
Maintenance	20
Before You Call for Service	21-22
If You Need Service	22
Warranty	23



1 For Future Assistance

Congratulations on your choice of a Jenn-Air electric wall oven. Your complete satisfaction is very important to us.

Read this user's guide carefully. It is intended to help you operate and maintain your new wall oven.

In addition, you will find a booklet entitled "**Cooking Made Simple.**" It contains information on selecting bakeware and provides baking, roasting and broiling tips.

Save time and money. Check the "Before You Call" section of this guide. It lists causes of minor operating problems that you can correct yourself.

However, should you need service, it is helpful to have the model and serial numbers available. This information can be found on the data plate located on the oven front frame.

These numbers are also on the Product Registration card that came with your appliance. Before sending in this card, record these numbers along with the purchase date below.

Model Number -----
Serial Number -----
Date of Purchase _____

IMPORTANT: *Keep this guide and the sales receipt in a safe place for future reference. Proof of original purchase date is needed for warranty service.*

If you have questions, write us (include your model number and phone number) or call:

Jenn-Air Customer Assistance
Attn: CAIR® Center
P.O. Box 2370
Cleveland, TN 37320-2370
1-800-688-1100
1-800-688-2080 (U.S. TTY for deaf, hearing
impaired or speech impaired)
(Mon. - Fri., 8 am-8pm Eastern Time)
Internet: <http://www.maytag.com>

For service information, see back page.

Notes . . .

- ◆ *In our continuing effort to improve the quality and performance of our cooking products, it may be necessary to make changes to the appliance without revising this guide.*
- ◆ *For Microwave Oven operation (select models), refer to the use and care guide packed in microwave oven.*

Important Safety Instructions 2

The following instructions are based on safety considerations and must be strictly followed to eliminate the potential risks of fire, electric shock, or personal injury.

Installation and Repair

- ◆ Have your appliance installed and properly grounded by a qualified installer according to the installation instructions.
- ◆ To ensure proper operation and avoid possible injury or damage to unit do not attempt to adjust repair, service, or replace any part of your appliance unless it is specially recommended in this book. All of the servicing should be referred to a qualified installer or servicer.

To Prevent Fire or Smoke Damage

- ◆ Be sure all packing materials are removed from the appliance before operating it.
- ◆ Keep area around appliance clear and free from combustible materials. Flammable materials should not be stored in an oven.
- ◆ Many plastics are vulnerable to heat. Keep plastics away from parts of the appliance that may become warm or hot.
- ◆ To prevent grease fires, do not let cooking grease or other flammable materials accumulate in or near the appliance.

In Case of Fire

- ◆ Use dry chemical or foam-type extinguisher or baking soda to smother fire or flame. Never use water on a grease fire.
 1. Turn off appliance to avoid spreading the flame.
 2. **NEVER** pick up or move a flaming pan.
 3. Smother fire or flame by closing the oven door.

Child Safety

- ◆ **NEVER** leave children alone or unsupervised near the appliance when it is in use or is still hot. Children should never be allowed to sit or stand on any part of the appliance as they could be injured or burned.

- ◆ Children must be taught that the appliance and utensils in it can be hot. Let hot utensils cool in a safe place, out of reach of small children. Children should be taught that an appliance is not a toy. Children should not be allowed to play with controls or other parts of the unit.

- ◆ **CAUTION: NEVER** store items of interest to children in cabinets above an appliance. Children climbing on the appliance or on the appliance door to reach items could be seriously injured.

About Your Appliance

- ◆ To prevent potential hazard to the user and damage to the appliance, do not use appliance as a space heater to heat or warm a room. Also, do not use the oven as a storage area for food or cooking utensils.
- ◆ Do not obstruct the flow of air by blocking the oven vent.
- ◆ **DO NOT TOUCH HEATING ELEMENTS OR INTERIOR SURFACES OF OVEN.** Heating elements may be hot even though they are dark in color. Interior surfaces of any oven become hot enough to cause burns. During and after use, do not touch, or let clothing or other flammable materials contact heating elements or interior surfaces of oven until they have had sufficient time to cool. Other surfaces of the appliance may become hot enough to cause burns – among these surfaces are: oven vent openings and surfaces near these openings, oven doors, windows of oven doors.
- ◆ **CAUTION: NEVER** use an appliance as a step to reach cabinets above. Misuse of appliance doors, such as stepping, leaning or sitting on the door, may result in possible tipping of the appliance, breakage of door, and serious injuries.
- ◆ Do not touch a hot oven light bulb with a damp cloth as the bulb could break. Should the bulb break, disconnect power to the appliance before removing bulb to avoid electrical shock.
- ◆ A fan should be heard during the bake, convection bake, convection roast, broil and cleaning cycles. If you do not hear the fan, call an authorized servicer.
- ◆ **NEVER** use aluminum foil to cover an oven rack or oven bottom. Misuse could result in risk of electric shock, fire, or damage to the appliance. Use foil only as directed in this guide.

3 Important Safety Instructions

Cooking Safety

- ◆ Never heat an unopened food container in the oven. Pressure build-up may cause container to burst resulting in serious personal injury or damage to the appliance.
- ◆ Use dry, sturdy potholders. Damp potholders may cause burns from steam. Dish towels or other substitutes should never be used as potholders because they can trail across hot elements and ignite or get caught on appliance parts.
- ◆ Wear proper apparel. Loose fitting or long hanging-sleeved apparel should not be worn while cooking. Clothing may ignite and cause burns if garment comes in contact with heating elements.
- ◆ Always place oven racks in the desired positions while oven is cool. Slide oven rack out to add or remove food, using dry, sturdy potholders. Always avoid reaching into the oven to add or remove food. If a rack must be moved while hot, use a dry potholder. Do not let potholder contact hot element in oven.
- ◆ Use care when opening the oven door. Let hot air or steam escape before removing or replacing food.
- ◆ **PREPARED FOOD WARNING:** Follow food manufacturer's instructions. If a plastic frozen food container and/or its cover distorts, warps, or is otherwise damaged during cooking, immediately discard the food and its container. The food could be contaminated.
- ◆ Do not allow aluminum foil or meat probe to contact heating element.
- ◆ Always turn off all controls when cooking is completed.

Utensil Safety

- ◆ Follow the manufacturer's directions when using oven cooking bags.
- ◆ This appliance has been tested for safe performance using conventional cookware. Do not use any devices or accessories that are not specifically recommended in this manual. Do not use add-on oven convection systems. The use of devices or accessories that are not expressly recommended in this guide can create serious safety hazards, result in performance problems, and reduce the life of the components of the appliance.
- ◆ Only certain types of glass, glass/ceramic, ceramic, earthenware, or other glazed utensils are suitable for oven service without breaking due to the sudden change in temperature. Follow utensil manufacturer's instructions when using glass.

Cleaning Safety

- ◆ Turn off all controls and wait for appliance parts to cool before touching or cleaning. Clean with caution. Use care to avoid steam burns if a wet sponge or cloth is used to wipe spills on a hot surface. Some cleaners can produce noxious fumes if applied to a hot surface.
- ◆ Clean only parts listed in this guide.

Self-Clean Oven

- ◆ Do not clean door gasket. The door gasket is essential for a good seal. Care should be taken not to rub, damage, or move the gasket.
- ◆ Do not use oven cleaners or oven liners of any kind in or around any part of the self-clean oven.
- ◆ Before self-cleaning the oven, remove broiler pan, oven racks and other utensils, and wipe off excessive spillovers to prevent excessive smoke or flare ups.
- ◆ **CAUTION:** Do not leave food or cooking utensils, etc. in the oven during the self-clean cycle.

Important Safety Notice and Warning

The California Safe Drinking Water and Toxic Enforcement Act of 1986 (Proposition 65) requires the Governor of California to publish a list of substances known to the State of California to cause cancer or reproductive harm, and requires businesses to warn customers of potential exposures to such substances.

Users of this appliance are hereby warned that when the oven is engaged in the self-clean cycle, there may be some low-level exposure to some of the listed substances, including carbon monoxide. Exposure to these substances can be minimized by properly venting the oven to the outdoors by opening the windows and/or door in the room where the appliance is located during the self-clean cycle.

IMPORTANT NOTICE REGARDING PET BIRDS: Never keep pet birds in the kitchen or in rooms where the fumes from the kitchen could reach. Birds have a very sensitive respiratory system. Fumes released during an oven self-cleaning cycle may be harmful or fatal to birds. Fumes released due to overheated cooking oil, fat, margarine and overheated non-stick cookware may be equally harmful.

SAVE THESE INSTRUCTIONS

Controls at a Glance 4

The control panel is designed for ease in programming. The display window shows time of day, timer and oven functions. Indicator words flash to prompt your programming steps. In double ovens (select models), "U" indicates upper oven is ON and "L" indicates lower oven is ON.

NOTE: Lower oven controls on double ovens only. Styling and features may differ slightly depending on the model.

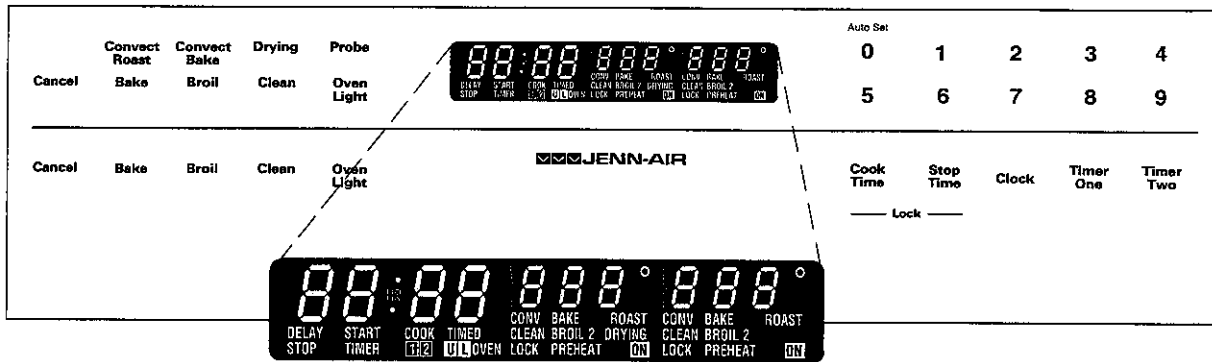

Function Pads

- ◆ Touch the desired pad.
- ◆ Touch the **Auto Set (0)** pad or the appropriate number pad(s) to enter time or temperature.
- ◆ A beep will sound when any pad is touched.

NOTE: Five seconds after entering the number, the time or temperature will automatically be entered. *If more than five seconds elapse between touching a function pad and the number pads, the function will be cancelled and the display will return to the previous display.*

Number Pads

Use to set time or temperature.

Cancel

Use to cancel all programming except Clock and Timer functions.

Bake

Use for conventional baking or roasting.

1. Press **Bake** pad.
2. Press the **Auto Set (0)** pad for 350° F or appropriate number pads for desired temperature.

See page 8 for additional information.

Broil

Use for top browning and broiling.

1. Press **Broil** pad.
2. Press the appropriate number pads to set broil temperature. The first number pressed will enter "Hi" broil.

See page 12 for additional information.

Clean

Use to set self-clean cycle.

1. Press **Clean** pad.
2. Press **Auto Set (0)** pad for "3:00" hours of cleaning, press the appropriate number pads for the time desired after "3:00" appears in the display. Press 2 for "2:00" hours or 4 for "4:00" hours.

See page 17-18 for additional information.

Convect Roast

Use for convection roasting.

1. Press **Convect Roast** pad.
2. Press the **Auto Set (0)** pad for 325° F or appropriate number pads for desired temperature.

See page 8 for additional information.

5 Controls at a Glance

Convect Bake

Use for convection baking.

1. Press **Convect Bake** pad.
2. Press the **Auto Set (0)** pad for 325° F or appropriate number pads for desired temperature.

See page 8 for additional information.

Drying

Use to dehydrate foods such as fruits, vegetables and herbs.

1. Press **Drying** pad.
2. Press the **Auto Set (0)** pad for 140° F or appropriate number pads for desired temperature.

See page 15-16 for additional information.

Probe

Use to set desired internal temperature of a food when using the Probe accessory.

1. Insert probe into food and oven receptacle.
2. Press **Probe** pad. Press the appropriate number pads to set the desired internal temperature of the food.
3. Press **Bake** or **Convect Roast** pad. Press the appropriate number pads for desired bake or roast temperature.

See page 11 for additional information.

Cook Time/Stop Time

Use to program the oven to start and stop automatically.

1. Press **Bake**, **Convect Bake**, or **Convect Roast** pad. Press the appropriate number pads for desired temperature.
2. Press **Cook Time** pad. Press the appropriate number pads to enter cooking time in hours and minutes.
3. To delay the start of cooking, press **Stop Time** pad. Press the appropriate number pads to enter the time you want the oven to stop.

See page 13-14 for additional information.

Setting the Clock

1. Press **Clock** pad.

◆ The indicator word **TIME** will flash in the display.

2. Press the appropriate number pads until the correct time of day appears in the display.

When electrical power is supplied or after a power interruption, the last clock time, before power was interrupted, will flash.

To recall the time of day when another time function is showing, press the **Clock** pad.

Clock time cannot be changed when the oven has been programmed for clock controlled oven operations or self-clean.

Setting the Timer One/Two

Use to set and then signal the completion of a time period up to 11 hours and 55 minutes (11:55).

The timers can be used independently of any other oven activity and can be set while another oven function is operating. *The timers do not control the oven.*

1. Press a **Timer** pad.

◆ The indicator word **TIMER** will flash along with # 1 or #2 plus "OHR:00" appears in the display.

2. Press the appropriate number pads until the desired number of minutes or hours and minutes appear in the display.

Example: To set Timer One for 5 minutes, press the **Timer One** pad and the number 5 pad. After five seconds, the display will show:

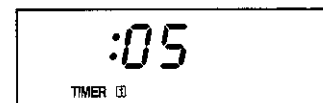

Example: To set Timer Two for 1 hour and 30 minutes, press the **Timer Two** pad and the numbers 1,3,0 pads. After five seconds the display will show:

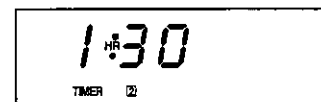

NOTE: If both timers are set, the timer with the least amount of time remaining will have display precedence.

3. At the end of the time set, the timer will chime four times and "End" will appear in the display. If the timer is not cancelled (see "To cancel" below), "End" will remain in the display and there will be two chimes every 30 seconds for five minutes.

To cancel:

1. Press and hold **Timer** pad. After a slight delay the time of day will reappear.

OR

2. Press the **Timer** pad and the "0" number pad. After a slight delay the time of day will reappear.

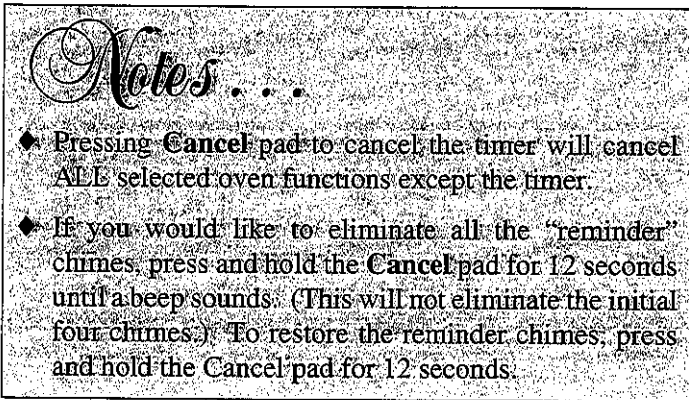

Oven Control Lockout

The oven operation controls - Bake, Broil and Self-Clean - can be locked in the "OFF" position. The Timer and Clock controls can always be used regardless of the lockout.

If an oven function is currently being used, the controls cannot be locked off.

To Set Controls

1. Press and hold the **Cook Time** pad and the **Stop Time** pad at the same time for several seconds.

◆ The indicator word "OFF" will appear and remain in the display for 15 seconds.

◆ If someone presses an oven function pad while controls are locked off, the indicator word "OFF" will reappear in the display for 15 seconds.

To cancel: Press and hold the **Cook Time** pad and the **Stop Time** pad at the same time for four seconds. The indicator word "OFF" will appear briefly and then disappear.

7 Oven Operation

Adjusting Oven Temperature

If you think the oven should be hotter or cooler, you can adjust it yourself. To decide how much to change the thermostat, set the oven temperature 25°F higher or lower than the temperature in your recipe, then bake. The results of the “test” should give you an idea of how much to adjust the thermostat.

To adjust the thermostat:

1. Press the **Bake** pad.
2. Enter 500° by pressing the number pads “5, 0, 0”.
3. Press and hold the **Bake** pad for several seconds until 00° appears in the display.
 - ◆ If the oven temperature was previously adjusted, the change will be displayed. For example, if the oven temperature was reduced by 15°, the display will show - 15°.
4. Press the appropriate number pads to select the temperature change desired.
 - ◆ The oven temperature can be increased up to 35° (+35°) or reduced by as much as 35° (-35°) in 5° increments.
 - ◆ Pressing the **Broil** pad will change the - sign to a positive number or back to a negative number.
5. The oven will now bake at the adjusted temperature. It is not necessary to readjust the oven temperature if there is a power interruption. This adjustment will not affect broil or clean temperatures.

NOTE: Do not change the temperature setting more than 10° at a time before testing the oven.

Oven Light

The oven light automatically comes on whenever the oven door is opened. When the door is closed, press the **Oven Light** pad to turn the oven light on or off. A beep will sound every time the **Oven Light** pad is touched.

Oven Vent

When the oven is in use, the area near the oven vent may feel warm to the touch. Do not block the vent opening for best baking results.

The oven vent is located below the control panel on your wall oven.

Baking, Roasting and Convection Cooking

Every oven has its own characteristics. You may find that the cooking times and temperatures vary slightly from your old oven. This is normal.

Oven Fans

A **cooling fan** will automatically turn on during cleaning, broiling and some baking operations. It is used to help keep internal parts on the control panel cool. The fan will automatically turn off when parts have cooled. The fan may continue to operate after the oven has been turned off. This is normal.

A convection fan is used to circulate hot air in the oven when the convection feature is selected. It automatically turns on whenever the **CONVECT** pads are pressed and will turn off when **CONVECT** is canceled.

NOTE: The convection fan will automatically stop whenever the oven door is opened.

Setting the Controls for Baking, Roasting, Convection Baking and Convection Roasting

1. Place oven racks on proper rack positions. (See page 9.)
2. Press **Bake, Convect Bake or Convect Roast** pad.
 - ◆ The indicator word **BAKE, CONV BAKE or CONV ROAST** will flash and three dashes will appear.
3. Press the **Auto Set (0)** pad to set 350° F automatically. When convection cooking, 325° F will automatically set when Auto Set (0) pad is pressed. Or, press the appropriate number pads for the desired oven temperature.
 - ◆ The temperature can be set from 100° to 550° F. in 5° increments.
 - ◆ After five seconds the oven will begin to preheat. The indicator words **ON** and **PREHEAT** will appear in the display and 100° or the actual oven temperature, whichever is higher.
 - ◆ The temperature in the display will increase in 5° increments until the oven reaches the preset temperature.

- ◆ When the oven is preheated, the oven will chime and the **ON** and **PREHEAT** indicator words will go off. Allow 7–11 minutes for the oven to preheat.

4. At the end of cooking, turn the oven off by pressing the **Cancel** pad. Remove food from oven. The oven will continue operating until the **Cancel** pad is pressed.

Notes . . .

- ◆ If more than five seconds elapse between pressing a pad and pressing a number pad, the display will return to the previous display.
- ◆ Whenever the **ON** indicator word appears in the display, the oven is heating.
- ◆ To recall the set temperature during preheat, press the **Bake, Convect Bake or Convect Roast** pad. The set temperature will be displayed briefly and then return to the on-going program.
- ◆ To change the oven temperature during cooking, press the **Bake, Convect Bake or Convect Roast** pad and the appropriate number pads for the desired oven temperature. If you are lowering the temperature below the current oven temperature, the indicator words **PREHEAT** and **ON** will appear briefly and the preheat chime will sound.
- ◆ *As a general rule when convection baking, set the oven temperature 25° F lower than the conventional recipe or prepared mix directions. Times will be similar to a few minutes less than directions. (See chart on page 10 to compare times and temperatures of many baked foods.)*
- ◆ When using the **Convect Roast** pad, roasting times are generally 25-30% less. (Maintain conventional roasting temperature.)
- ◆ For additional baking, roasting and convection cooking tips, plus a roasting chart with recommended roasting temperatures and times, see **"Cooking Made Simple"** booklet.

9 Oven Operation

Convection Cooking of Convenience Foods

- ◆ For best results, use the **Convect Roast** pad.
- ◆ Preheating the oven is **not** necessary.
- ◆ Follow package recommendations for oven temperature, foil covering and the use of cookie sheets. Cooking times will be similar. (See chart below for some exceptions.)
- ◆ Most foods are cooked on rack position #3o (offset on #3).
- ◆ For multiple rack cooking with convection, use racks #1 and 3o and 4. However, pizzas should be placed on cookie sheets and cooked on rack positions #2o, 3 and 4.

Cooking Chart for Convenience Foods		Convect Roast, Oven Not Preheated	
Frozen Convenience Foods	Rack Position*	Temp. ° F	Minutes **
Chicken, fried	3o	375°	40-45
Fish Sticks	3	400°	13-18
French Fries	3	450°	15-25
Pot Pies	3o	400°	30-35
Pizza	3o	400°	13-18

* An "o" after a rack number implies that the offset rack should be used.
 ** The times given are based on specific brands of mixes or recipes tested. Actual times will depend on the ones you cook.

Oven Racks

Single Oven – two flat racks and one offset rack were packaged with your oven.

Double Oven – two flat racks and one offset rack plus an additional offset and flat rack for the lower oven were packaged in your oven.

To remove: Pull forward to the "stop" position; lift up on the front of the rack and pull out.

To replace: Place rack on the rack support in the oven; tilt the front end up slightly; slide rack back until it clears the lock-stop position; lower front and slide into the oven.

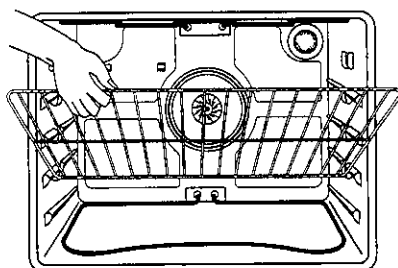

Rack Positions

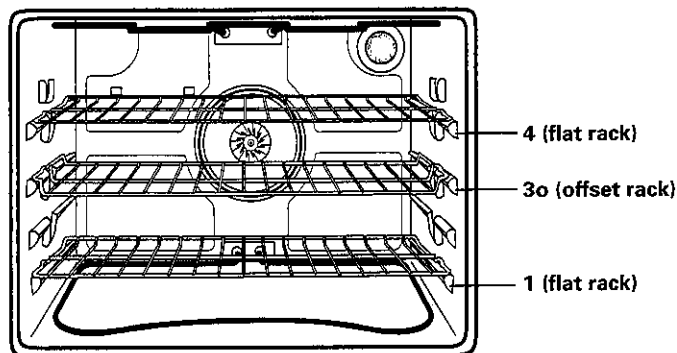

Three rack convection cooking.

Rack Position #4o (offset rack on #4):
Most broiling.

Rack Position #3:
Most baked goods on a cookie sheet or jelly roll pan.

Rack Position #3o (offset rack on #3):
Most baked goods, pies, layer cakes.

Rack Position #2:
Roasting small cuts of meat, cakes in tube or bundt pans, casseroles.

Rack Position #2o (offset on #2):
Roasting, loaves of bread, angel food cake.

Rack Position #1:
Large cuts of meat and turkey, custard pie, dessert souffle.

Multiple Rack Cooking:

Two racks: Use #2o and #4.

Three racks (convection cooking): Use #1, #3o, #4. (See illustration above.)

Notes . . .

- ◆ The use of the offset rack is denoted in the list above and in the charts as an "o" after the rack position number.
- ◆ Do not cover an entire rack with aluminum foil or place foil on the oven bottom. Baking results will be affected and damage may occur to the oven bottom.

Baking Chart						
Product and Type	Pan Size	Rack Position	Convection Bake		Conventional Bake	
			Preheated Temp. (°F)**	Min.**	Preheated Temp. (°F)	Min.**
Cake						
White - 2 layer	9"	3o or 3	325°	20-30	350°	25-30
Chocolate - 2 layer	9"	3o or 3	325°	25-30	350°	30-35
Angel Food	tube	2o or 2	350°	30-35	375°	30-40
Round Cake	9x5 loaf	2	300°	50-60	325°	55-65
Cupcakes	2 pans	2o & 4	325°	15-20	350°	15-25
Pie - Two Crust	9"	3o	350°-400°	45-60	375°-425°	45-60
Fruit Fresh						
Pie - One Crust	9"	1	325°-375°	40-50	350°-400°	40-60
Custard Fresh						
Cookies						
Chocolate Chip	3	3o or 3	325°-350°	6-10	350°-375°	7-11
Sugar	3	3o or 3	325°-375°	6-10	350°-400°	7-11
Brownies	9x13"	3o	325°	20-26	350°	25-31
Breads - Yeast						
Loaf	9x5"	1 or 2o	350°	17-23	375°	18-28
Rolls		3o	350°-375°	9-14	375°-400°	12-15
Breads - Quick						
Loaf	8x4"	2o	325°-350°	40-55	350°-375°	50-65
Cornbread	8x8"	3o	375°-420°	13-28	400°-450°	15-30
Biscuits		3 or 3o	375°-400°	7-11	400°-425°	8-15
Muffins		3o	350°-400°	15-20	375°-425°	15-25
Vegetables						
Potatoes (med.) Do not wrap in foil, prick with fork.		3o	400°	45-50	425°	55-65
Squash	Casserole	3o	325°	45-55	350°	55-65

* An "o" after a rack number implies that the offset rack should be used.

** The times given are based on specific brands of mixes or recipes tested. Actual times will depend on the ones you bake.

*** The Convection Bake temperature is 25° F lower than recommended on package mix or recipe.

11 Oven Operation

Probe

To assure excellent results every time when roasting, use the probe supplied with your wall oven.

Installing and Setting the Probe

1. Insert the probe into the food item. (For meats, the probe tip should be located in the center of the thickest part of the meat and not into the fat or touching a bone.)

2. Insert the probe plug into the receptacle located on the top left of the oven. Be certain to insert plug into the receptacle all the way.

- ◆ After the probe is inserted, the indicator word **PROBE** will flash and a beep will sound reminding you to enter the desired probe temperature.

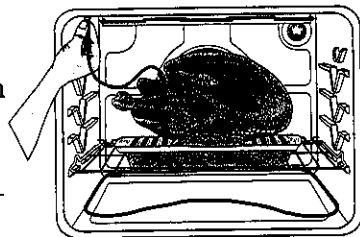

3. Press **Probe** pad. The display will show three dashes.

4. Press the appropriate number pads to set the internal temperature desired. (Allowable range is 100° to 200°F.)

- ◆ After five seconds the display will show probe temperature or 95°, whichever is higher. Indicator words **CONV**, **BAKE**, **ROAST** will flash.

5. Press **Bake** or **Convect Roast** pad. The display will show three dashes.

6. Press the appropriate number pads for desired oven temperature.

7. When the selected internal temperature of the food has been reached, the oven will shut off and a chime will sound four times. Plus, the actual probe temperature will flash and the word "End" will be shown in the display.

A chime will sound every minute for 10 minutes or until the **Cancel** pad is pressed.

- ◆ If the probe is not removed, a beep will sound continuously until the probe is removed. (Hold probe plug with a potholder when removing from the oven.)

Notes . . .

- ◆ The probe must be removed from the oven when it is not being used.
- ◆ Because of the excellent insulation of the oven, the retained heat continues to cook the food after the signal has sounded and the oven has cycled off. For this reason it is important to remove the food from the oven as soon as the signal sounds.
- ◆ Use the handle of the probe for inserting or removing. Do not pull on the cable. Use a potholder to remove since probe becomes hot.
- ◆ For frozen meats, insert probe after 1-2 hours of roasting.
- ◆ To clean cooled probe, wipe with a soapy dishcloth. *Do not submerge probe in water.*

Broiling

For best results, use a pan designed for broiling. For additional broiling tips, see *"Cooking Made Simple"* booklet.

Setting the Controls for Broiling

1. Place the oven rack on the proper rack position. (See following chart.)
2. Press the **Broil** pad.
 - ◆ Indicator word BROIL will flash and three dashes will appear.
3. Press the appropriate number pad(s). The first number pad pressed will enter **"Hi"** broil.
 - ◆ The oven has a variable broil feature which means that a lower broil temperature can be selected. To select a lower temperature, press the appropriate number pads for the temperature desired after **"Hi"** appears in the display.
 - ◆ Five seconds after entering **"Hi"** or a temperature, the broil element will come on and the indicator words BROIL and ON will remain in the display. (If a lower temperature is selected, the ON indicator word will cycle on and off with the element.)
4. Preheat five minutes until broil element is red. Cook food according to the following broiling chart. *Oven door MUST be left open at the broil stop position during cooking.*
5. Press the **Cancel** to turn off oven when food is cooked.

Broiling Chart			
Chart time based on a preheated broil element using the "Hi" setting			
Foods	Rack Position	Approx. (Minutes/Side)	
		1st Side	2nd Side
Beef			
Steak (1")			
Medium	4o	9	7
Well	4o	11	8
Hamburgers (3/4")			
Medium	4o	5	3-4
Well	4o	6	4-5
Pork			
Chops (1/2")	4o	7	5-6
Chops (1")	3	10-11	9-10
Ham Slice	4o	4	2-3
Poultry			
Breast Halves (Bone-in)	3	11-12	9-11
Seafood			
Fish Steaks, Buttered (1")	4o	8-10	(no turning)

*An "o" after the rack number implies that the offset rack should be used.

Note: This chart is a suggested guide. The times may vary with food being cooked.

Notes . . .

- ◆ If more than five seconds elapse between pressing the **Broil** pad and number pad, the oven is not set and the display will return to the previous display.
- ◆ **"Hi"** is used for most broiling. Use a lower broil temperature when broiling longer cooking foods or thin pieces of food. The lower temperature allows food to cook to the well done stage without excessive browning.
- ◆ A cooling fan will automatically turn on during broiling. If it does not operate, contact an authorized servicer.
- ◆ Expect broil times to increase and browning to be slightly lighter if appliance is installed on a 208 volt circuit.

13 Oven Operation

Clock Controlled Oven Operations

The clock controlled oven cooking feature is used to turn the oven off at a preset time of day or delay the start and then turn off the oven.

The clock must be functioning and set at the correct time of day for this feature to operate correctly.

The feature can be used with either oven cooking or self-cleaning. See page 18 for instructions on delaying the start of a clean cycle.

Setting the Controls

To Start Immediately and Turn Off Automatically:

1. Press the **Bake** pad.
 - ◆ The indicator word **BAKE** will flash and three dashes will appear in the display.
2. Press the **Auto Set (0)** pad or the appropriate number pads for the desired oven temperature.
 - ◆ The temperature can be set from 100° to 550° in 5° increments.
 - ◆ After five seconds the oven will begin to preheat. The indicator words **ON** and **PREHEAT** will appear in the display and 100° or the actual oven temperature, whichever is higher.
3. Press the **Cook Time** pad. The indicator words **COOK TIME** will flash and the display will show "0HR:00".
4. Press the appropriate number pads to enter cooking hours and minutes. (Allowable range is 5 minutes to 11 hours and 55 minutes.)

Example: If cooking time selected for convection baking is 2 hours and 30 minutes, the display will show:

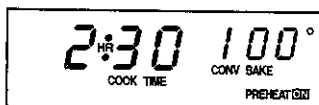

After five seconds, the time of day returns to the display.

- ◆ The temperature in the display will increase in 5° increments until the oven reaches the preset temperature.
 - ◆ When the oven is preheated, the oven will chime and the **ON** and **PREHEAT** indicator words will go off.
5. At the end of the programmed Cook Time, the oven will shut off automatically and a "chime" will be heard four times and "End" will appear in the display. Press the **Cancel** pad.

If oven is not cancelled, "End" will remain in the display and there will be one chime every minute for 10 minutes.

Notes

- ◆ One minute before the end of Cook time, the oven light will come on until the end-of-cycle chimes are completed. The light can be turned off prior to the end of the chimes by pressing the **Oven Light** pad or pressing the **Cancel** pad. (Pressing the **Cancel** pad will also cancel the operation.)

To Delay the Start and Turn Off Automatically:

- 1-4. Follow preceding steps 1-4.
5. Press the **Stop Time** pad. Indicator words **STOP** and **TIME** will flash. (Display will show the calculated stop time based on the current time of day and the cook time that you entered previously.)

6. Press the appropriate number pads to enter the time you wish the oven to stop. A stop time can only be accepted for later in the day.

Example: If at 10:00 you set the oven for 350° convection baking and 2 hours and 30 minutes of cooking time, the calculated stop time would be "12:30". The display would show:



If you want the stop time to be 1:00, press the number pads "1,0,0. Five seconds later, the display will briefly show the start time of 10:30 along with the indicator words DELAY, START TIME.

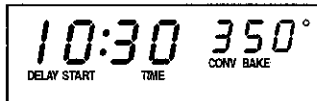

After five seconds, the display will return to the current time of day along with the indicator words DELAY, TIMED.

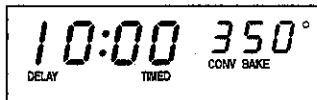

At the end of the delayed period, the DELAY indicator word will go off and the oven will begin to heat.

7. At the end of the programmed Cook Time, the oven will shut off automatically and a "chime" will be heard four times and "End" will appear in the display. Press the Cancel pad.

If the oven is not cancelled, "End" will remain in the display and there will be one chime every minute for 10 minutes.

Notes...

- ◆ If more than five seconds elapse between pressing a function pad and pressing the appropriate number pads, the oven is NOT set and display will return to the previous display.
- ◆ In double wall ovens, the clock controlled feature can be used with only one oven at a time.
- ◆ In double wall ovens, if one oven is set for clock controlled baking, the other oven cannot be set to self-clean.
- ◆ To recall the time programmed, press the appropriate time pad.
- ◆ To cancel a timed function, hold the Cook Time pad for four seconds. This will only cancel the cook time and stop time, not the set bake temperature.
- ◆ Clock controlled cooking is not recommended for baked items that require a preheated oven, such as cakes, cookies, pies and breads. For these foods, place food in preheated oven and set the timer to signal the end of baking time.
- ◆ Highly perishable foods such as dairy foods, pork, poultry or seafood are not recommended for clock controlled cooking with a delayed start.

15 Oven Operation

Drying

For best results, use a drying rack. It allows air to circulate evenly around the food.

The convection fan will operate during the drying procedure.

Setting the Controls for Drying

1. Press the Drying pad.

- ◆ The indicator word DRYING will flash and three dashes will appear.

2. Press the Auto Set pad for 140° F or press the appropriate number pads for the desired drying temperature.

- ◆ The temperature may be set between 100° - 200° F.

3. The oven door needs to be opened slightly to allow moisture to escape from the oven during the drying process.

- ◆ Open the oven door slightly.

- ◆ Place the magnetic door spacer (Part No. 8010P131-60) on the slightly recessed circular area on the upper center of the oven door. The spacer provides a gap between the oven frame and the oven door allowing moisture to escape.

NOTE: If the spacer is not placed correctly, the convection fan will not operate.

- ◆ Gently close the oven door until the spacer rests against the oven frame and light plunger. The oven light will remain OFF when the spacer is in the correct location.

Follow the drying guide on page 16 for drying times. Cool foods to room temperature before testing for doneness.

4. When drying is complete, turn the oven off by pressing the Cancel pad. Using a potholder, remove the magnetic spacer.

NOTE: Please keep the magnetic spacer in a safe and convenient place for easy access. To replace, call 1-800-688-8408 to order Part No. 8010P131-60.

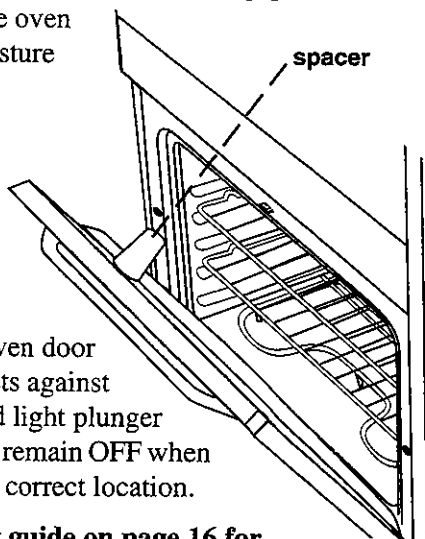

Notes . . .

- ◆ To purchase a drying rack, contact your Jenn-Air dealer for the "DRYING RACK" Accessory Kit or call 1-800-688-8408.

- ◆ Most fruits and vegetables dry well and retain their color when dried at 140° F. Meat and jerky should be dried at 145° - 150° F. For optimal flavor, dry herbs at 100° F. However, at this lower temperature expect extended drying times of up to 8 hours.

- ◆ The length of drying times vary due to the following: Water and sugar content of food, size of food pieces, amount of food being dried, humidity in the air.

- ◆ Check foods at the minimum drying time. Dry longer if necessary.

- ◆ Fruits that turn brown when exposed to air should be treated with an antioxidant. Try one of the following methods:

1. Dip fruit in a mixture of two parts bottled lemon juice to one part cool water.
2. Soak fruit in a solution of 1 tsp. ascorbic acid or commercial antioxidant to 1 quart of cold water.

- ◆ Foods may drip during the drying process. After drying high acid or sugary foods, clean the oven bottom with soap and water. The porcelain oven finish may discolor if acid or sugary food soils are not wiped up prior to high heat or a self-cleaning cycle.

- ◆ More than one rack of food may be dried at the same time. However, additional drying time is needed.

- ◆ Refer to other resources at your local library or call your local County Extension service for additional information.

Drying Guide				
Fruits	Varieties Best for Drying	Preparation	Approx. Drying Time at 140°F **	Test for Doneness
Apples*	Firm Varieties: Graven Stein, Granny Smith, Jonathan, Winesap, Rome Beauty, Newton	Wash, peel if desired, core and slice into 1/8" slices.	4-8 hours	Pliable to crisp. Dried apples store best when they are slightly crisp.
Apricots*	Blenheim/Royal most common. Tilton also good	Wash, halve, and remove pits.	18-24 hours	Soft, pliable.
Bananas*	Firm Varieties	Peel and cut into 1/4" slices.	17-24 hours.	Pliable to crisp.
Cherries	Lambert, Royal Ann, Napoleon, Van or Bing	Wash and remove stems. Halve and remove pits.	18-24 hours.	Pliable and leathery.
Nectarines and Peaches*	Freestone Varieties	Halve and remove pits. Peeling is optional but results in better-looking dried fruit.	24-36 hours	Pliable and leathery.
Pears*	Bartlett	Peel, halve and core.	24-36 hours	Soft and pliable.
Pineapple	Fresh or canned.	Wash, peel and remove thorny eyes. Slice length wise and remove the small core. Cut crosswise into 1/2" slices.	Canned: 14-18 hours Fresh: 12-16 hours	Soft and pliable.
Orange and Lemon Peel	Select rough-skinned fruit. Do not dry the peel of fruit marked "color added"	Wash well. Thinly peel the outer 1/16 to 1/8" of the peel. Do not use the white bitter pith under the peel.	1-2 hours	Tough to brittle.
Vegetables				
Tomatoes	Plum, Roma	Halve, remove seeds. Place tomatoes skin side up on rack. Prick skins.	12-18 hours	Tough to crisp.
Carrots	Danvers Half Long, Imperator, Red Cored Chantenay	Do not use carrots with woody fiber or pithy core. Wash, trim tops and peel if desired. Slice crosswise or diagonally in 1/4" slices. Steam blanch for 3 min.	4-8 hours	Tough to brittle.
Hot Peppers	Ancho, Anaheim	Wash, halve and seed. Prick skin several times.	4-6 hours	Pods should appear shriveled, dark red and crisp.
Herbs				
Parsley, Mint, Cilantro, Sage, Oregano		Rinse in cold water. Leave stems on until leaves are dry, then discard.	1-3 hours	Brittle and crumbly.
Basil		Cut leaves 3 to 4" from top of plant just as buds appear. Rinse leaves in cold water.	2-5 hours	Brittle and crumbly.

*Fruits requiring an antioxidant to prevent discoloration and loss of nutrients. Refer to the notes on page 10 for specific methods.

** 12 Hour Off will not occur during drying functions.

17 Care and Cleaning

Self-Clean Oven

The self-clean cycle uses above normal cooking temperatures to automatically clean the entire oven interior. While this occurs, a device in the oven vent helps consume normal amounts of smoke. The oven is vented through an opening under the control panel.

NOTE: Both ovens cannot be self-cleaned at the same time in double wall oven models.

It is normal for flare-ups, smoking or flaming to occur during cleaning if the oven is heavily soiled.

It is better to clean the oven regularly rather than to wait until there is a heavy build-up of soil in the oven.

During the cleaning process, the kitchen should be well ventilated to help eliminate normal odors associated with cleaning.

Do not use commercial oven cleaners on the self-clean oven finish or around any part of the oven as they will damage the finish or parts.

Before Self-Cleaning

Remove broiler pan, all pans and the oven racks from the oven. **The oven racks will discolor and may not slide easily after a self-clean cycle.**

Clean oven frame, door frame (area outside the door gasket) and around the opening in the door gasket with a non-abrasive cleaning agent such as Bon Ami* or detergent and water. These areas are not exposed to cleaning temperatures and should be cleaned to prevent soil from baking on during the clean cycle.

To prevent damage, do not clean or rub the gasket around the oven door.

The gasket is designed to seal in heat during the clean cycle.

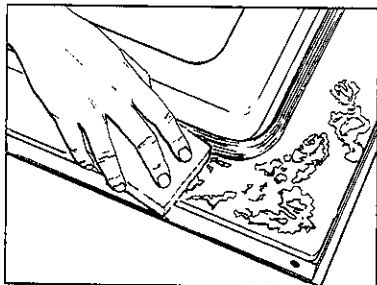

Wipe up excess grease or spillovers from the oven bottom to prevent excessive smoking, flare-ups or flaming during the clean cycle. For ease of cleaning, the heating element can be lifted slightly (1 to 1-1/2 inches).

Wipe up sugary spillovers and acid spillovers such as lemon juice, tomato sauce or milk-based sauces. Porcelain enamel is acid resistant, not acid proof. **The porcelain finish may discolor if acid spills are not wiped up prior to a self-clean cycle.**

Setting the Controls for a Self-Clean Cycle

1. Close the oven door.
2. Press the **Clean** pad.
 - ◆ The indicator words **CLEAN TIME** will flash and the display will show “__HR: __”. (Double wall oven models will also have a “U” or “L” indicating upper or lower oven.)
3. Press **Auto Set (0)** pad and “3:00” hours will appear in the display for an average soiled oven.
 - ◆ The cleaning time can be varied depending on the amount of soil. After “3:00” appears in the display, press the number 2 pad and enter “2:00” hours of cleaning for light soil. The number 4 pad will enter “4:00” hours for heavy soil.
 - ◆ Five seconds after entering the cleaning time, the oven door will automatically latch and the cooling fan will come on.
 - ◆ The indicator words **LOCK** and **ON** will come on when the door is latched.
 - ◆ The indicator word **ON** will cycle with the elements as the cleaning temperature is maintained.
4. When the cleaning time has been completed, the indicator words **CLEAN** and **ON** will go off. The indicator word **LOCK** and the cooling fan will remain on until the oven has cooled and the door has unlocked.

After Self-Cleaning

About one hour after the end of the clean cycle, the lock will disengage and the LOCK indicator word will turn off. At this point, the door can be unlocked and opened.

Some soil may leave a light gray, powdery ash which can be removed with a damp cloth. If soil remains, it indicates that the clean cycle was not long enough. The soil will be removed during the next clean cycle.

If the oven racks were left in the oven and do not slide smoothly after a clean cycle, wipe racks and embossed rack supports with a small amount of vegetable oil to restore ease of movement.

A white discoloration may appear after cleaning if acid or sugary foods were not wiped up before the clean cycle. This is normal and will NOT affect performance.

To Delay the Start of a Clean Cycle

- 1-3. Follow steps 1-3 on page 14.
4. Press the **Stop Time** pad. Indicator words STOP TIME will flash in the display and CLEAN and the calculated stop time will also appear in the display.
5. Press the appropriate number pads to enter the stop time. A stop time can only be accepted for later in the day.

Example: If at 9:00 you set the oven to clean for three hours, the calculated stop time would be "12:00". The display will show:



If you want the stop time to be 1:00, press the number pads "1,0,0". Five seconds later the display will briefly show the start time and the indicator word DELAY.



After a brief time, the display will return to the current time of day with the indicator words DELAY TIMED CLEAN remaining in the display.



When the oven begins to clean, the indicator word ON and the cooling fan will come on. The indicator word DELAY will go off.

When the clean time has been completed, the indicator words CLEAN and ON will go off. The indicator word LOCK and the cooling fan will remain on until the oven has cooled down and the door has been unlocked.

To Cancel Self-Clean

1. Press the **Cancel** pad. The door will be locked while the LOCK indicator word remains in the display.

Depending on the length of time the oven had been cleaning, it may take up to an hour for the oven to cool down. When the oven is cool the door will unlock and the cooling fan will turn off.

Notes...

- ◆ **CAUTION:** It is normal for parts of the wall oven to become hot during a clean cycle. Therefore, during a clean cycle, avoid touching the oven vent area, oven door and window.
- ◆ If the oven door is left open, "door" will flash in the display, and a signal will beep until the door is closed and the **Clean** pad is pressed again.
- ◆ A fan will automatically turn on during the self-clean cycle and will automatically turn off after the clean cycle when the oven has cooled. If it does not operate, contact an authorized service.
- ◆ If more than five seconds elapse between pressing the **Clean** pad and pressing a number pad, the program will automatically return to the previous display.
- ◆ The oven door will be damaged if the oven door is forced to open when the **LOCK** indicator word is still displayed.
- ◆ The first few times the oven is cleaned, some smoke and odor may be detected. This is normal and will lessen or disappear with use. If the oven is heavily soiled, or if the broiler pan was accidentally left in the oven, excessive smoke and odor may occur.
- ◆ As the oven heats and cools, you may hear sounds of metal parts expanding and contracting. This is normal and will not damage your appliance.

19 Care and Cleaning

Be sure all controls are OFF and all parts are cool before cleaning.

◆ To prevent staining or discoloration, clean appliance after each use.

◆ If a part is removed, be sure it is correctly replaced.

Cleaning Chart

Parts

Cleaning Procedure

Broiler Pan and Insert

Never cover insert with aluminum foil as this prevents the fat from draining to the pan below.

- ◆ Place soapy cloth over insert and pan; let soak to loosen soil.
- ◆ Wash in warm, soapy water. Use soap-filled scouring pad to remove stubborn soil.
- ◆ Broiler pan and insert can be cleaned in dishwasher.

Control Panel

- ◆ Wipe with a damp cloth. Dry thoroughly.
- ◆ Glass cleaners may be used if sprayed on a cloth first. **Do Not Spray Directly On The Panel.**
- ◆ Do not use other cleaning sprays, abrasive cleaners or large amounts of water on the panel.

Elastic Finishes - Door Handle Area

- ◆ Wash with soap and water or mild liquid sprays and a soft cloth. Do not use abrasive cleaners or oven cleaners on plastic finishes.
- ◆ To prevent staining or discoloration, wipe up fat, grease or acid (tomato, lemon, vinegar, milk, fruit juice, marinade) immediately with a dry paper towel or cloth.

Glass - Window - Oven Door

- ◆ Wash with soap and water or glass cleaner. Avoid using excessive amounts of water which may seep behind or under the glass.
- ◆ Do not use abrasive cleaners.

Metal Finishes - Oven Body

- ◆ Wash with soap and water, glass cleaners or mild liquid sprays. Avoid using excessive amounts of water.
- ◆ Remove stubborn soils with nonabrasive cleaners such as Bon Ami* or a baking soda and water paste; rinse and dry. Do not use abrasive cleaners.

Oven Interior

- ◆ See pages 17 and 18 for information on the self-clean oven.
- ◆ To remove occasional spillovers between cleanings, use a plastic soap-filled scouring pad; rinse well.
- ◆ Wipe up sugary spillovers and acid spillovers such as lemon juice, tomato sauce or milk-based sauces. Porcelain enamel is acid resistant, not acid proof. The porcelain finish may discolor if acid spills are not wiped up prior to a self-clean cycle.

Oven Racks

- ◆ Rub with a sponge or cloth using one of the following cleaners: Bon-Ami*, Soft Scrub* or Comet*. Rinse and dry.
- ◆ For hard to remove soils, use a dampened soap-filled scouring pad. Rinse and dry.
- ◆ Racks will permanently discolor and may not slide smoothly if left in the oven during a self-clean operation. If this occurs, wipe the rack and embossed rack supports with a small amount of vegetable oil to restore ease of movement, then wipe off excess oil.

* Brand names for cleaning products are registered trademarks of the respective manufacturers.

About Cleaning Products

Because of the many new cleaning products introduced in the marketplace each year, it is not possible to list all products that can be safely used to clean this appliance. Listed below are just a few examples of recommended products.

REMEMBER, ALWAYS READ THE MANUFACTURER'S INSTRUCTIONS to be sure the cleaner can be safely used on this appliance.

To determine if a cleaning product is safe, test a small inconspicuous area using a very light pressure to see if the surface may scratch or discolor. This is particularly important for porcelain enamel, highly polished, shiny, painted, or plastic surfaces.

The following brands may help you to make an appropriate selection:

- ◆ **Glass Cleaners** - Cinch, Glass Plus, Windex.
- ◆ **Dishwashing Liquid Detergents** - Dawn, Ivory, Joy.
- ◆ **Mild Liquid Spray Cleaners** - Fantastik, Formula 409.
- ◆ **Multi-Surface Cleaners** - Formula 409 Glass & Surface, Windex Glass & Surface.
- ◆ **Nonabrasive Cleaners** - Bon Ami, paste of baking soda and water.
- ◆ **Mildly Abrasive Powder or Liquid Cleaners** - Ajax, Barkeepers Friend, Cameo, Soft Scrub, Smart Cleanser. (Note: If the cleaner is recommended for use on plastic, glass, or porcelain finishes, it can be used on the same type of appliance finish.)
- ◆ **Nonabrasive or Scratchless Plastic or Nylon Scouring Pads or Sponges** - Chore Boy Plastic Cleaning Puff, Scrunge Scrub Sponges, Scotch-Brite No Scratch Pads.
- ◆ **Abrasive Scouring Pads** - S.O.S., Brillo Steel Wool Soap, Scotch-Brite Wool Soap Pads.

(Brand names for the above cleaning products are registered trademarks of the respective manufacturers.)

Oven Light

Before replacing light bulb, DISCONNECT POWER TO OVEN. Be sure bulb is cool. Do not touch a hot bulb with a damp cloth as the bulb may break.

To replace oven light:

Use a dry potholder and very carefully unscrew bulb cover and bulb. Replace with a 40 watt, oven-rated appliance bulb. Bulb with a brass base is recommended to prevent fusing of bulb into socket.

Replace bulb cover and reconnect power to oven. Reset clock.

Oven Window

To protect the oven door window:

1. Do not use abrasive cleaning agents such as steel wool scouring pads or powdered cleansers as they may scratch the glass.
2. Do not hit the glass with pots, pans, furniture, toys, or other objects.
3. Do not close the oven door until the oven racks are in place.

Scratching, hitting, jarring or stressing the glass may weaken its structure causing an increased risk of breakage at a later date.

21 Before You Call for Service

Check the following list to be sure a service call is really necessary. A quick reference of this guide may prevent an unneeded service call.

If the oven fails to operate:

- ◆ Check for a blown fuse or a tripped circuit breaker.
- ◆ Check if oven is properly connected to electric outlet.

If clock, indicator words, and/or lights operate but oven does not heat:

- ◆ The controls may have been set incorrectly.
- ◆ Clock controls may be set for a delayed bake function.
- ◆ The Oven Control Lockout may have been set. (See page 6.)

If the oven light and/or clock does not function:

- ◆ The light bulb is loose or defective.
- ◆ Check power supply, circuit breaker or fuse.
- ◆ The oven light does not work during self-cleaning process.

There is a strong odor or light smoke when oven is turned on:

- ◆ This is normal for a new wall oven and will disappear after a few uses. Initiating a clean cycle will "burn off" the smells more quickly. Turning on a ventilation fan will help remove the smoke and/or odor.
- ◆ Excessive food soils on the oven bottom. Use a self-clean cycle.

If oven will not activate the self-cleaning process:

- ◆ Controls may be improperly set.
- ◆ Check the "Clean" and "Stop" time settings and the current time of day on the clock.

If oven did not clean properly:

- ◆ Oven may need longer cleaning time.
- ◆ Excessive spills were not removed prior to self-cleaning process.

If foods do not broil properly:

- ◆ The control may not be set properly.
- ◆ Check rack position. (See pages 9 and 12.)
- ◆ Voltage into house may be low.

If baked food is burned or too brown on top:

- ◆ Food may be positioned incorrectly in oven. (See "*Cooking Made Simple*" booklet.)
- ◆ Oven not preheated properly.

If foods bake unevenly:

- ◆ The oven may be installed improperly.
- ◆ Check the oven rack with a level.
- ◆ Stagger pans, do not allow pans to touch each other or oven wall.
- ◆ Check instructions for suggested placement of pans on oven rack. (See "*Cooking Made Simple*" booklet.)

If oven door will not unlock:

- ◆ Oven may not have cooled to safe temperature after self-cleaning process.

If oven baking results are less than expected:

- ◆ The pans being used may not be of the size or material recommended for best results. (See "*Cooking Made Simple*" booklet).
- ◆ There may not be sufficient room around sides of the pans for proper air circulation in the oven.
- ◆ Check instructions for preheating, rack position and oven temperature.
- ◆ Check oven temperature when convection baking. Decrease conventional baking temperatures by 25°F.

If baking results differ from previous oven:

- ◆ Oven thermostat calibration may differ between old and new ovens. Follow recipe and use the directions in this guide before calling for service since the calibration on the previous oven may have drifted to a too high or too low setting. (See p. 7 - Adjusting Oven Temperature.)

If the cooling fan continues to operate after the oven has been turned off:

- ◆ This is normal and the fan will automatically shut off when the oven is cooled.

If a fan is heard while using the broil and clean modes:

- ◆ This is the cooling fan and is normal. The fan will continue to run after use until the oven cools.

If probe does not work:

- ◆ check to be sure probe plug is properly inserted into oven receptacle.
- ◆ probe may not be positioned in food properly.
- ◆ probe temperature may have been improperly set.

If convection fan does not operate during drying:

- ◆ Check that the magnetic door spacer was correctly placed on the slightly recessed circular area on the upper center of the oven door. (See pages 15 and 16.)

Fault Codes

- ◆ Fault codes are shown in the display as "F" and a number. If a fault code appears in the display and beeps sound, press the **Cancel** pad. If the fault code and beeps continue after pressing **Cancel**, disconnect power to the oven. Wait a few minutes, then reconnect power to the oven. If the fault code and beeps still continue, disconnect power to the wall oven and call an authorized servicer.
- ◆ If the oven is heavily soiled, excessive flare-ups may result in a fault code during a clean cycle. Press **Cancel** pad and allow the oven to cool for one hour, then reset the clean cycle. If the fault code and beeps still continue, disconnect power to the appliance and call an authorized servicer.
- ◆ If an error beep sounds (two short beeps) with no fault code in the display, clean any spill from key pad area within 30 seconds. If, after 30 seconds the spill is not removed or another problem exists, an F7 fault code will be displayed. Disconnect power to the appliance and call an authorized servicer.

If You Need Service:

- ◆ Call the dealer from whom your appliance was purchased or call Maytag Appliances Sales Company, Jenn-Air Customer Assistance at 1-800-688-1100 or 1-423-472-3333 to locate an authorized servicer.
- ◆ Be sure to retain proof of purchase to verify warranty status. Refer to **WARRANTY** (last page) for further information of owner's responsibilities for warranty service.
- ◆ If the dealer or service company cannot resolve the problem, write to Maytag Appliances Sales Company, Attn: CAIR® Center, P.O. Box 2370, Cleveland, TN 37320-2370, or call **1-800-688-1100** or **1-423-472-3333**.

U.S. customers using TTY for deaf, hearing impaired or speech impaired, call 1-800-688-2080.

NOTE: When writing or calling about a service problem, please include the following information:

- a. Your name, address and telephone number;
- b. Model number and serial number;
- c. Name and address of your dealer or servicer;
- d. A clear description of the problem you are having;
- e. Proof of purchase (sales receipt).

- ◆ User's guides, service manuals, and parts information are available from Maytag Appliances Sales Company, Jenn-Air Customer Assistance.

All specifications subject to change by manufacturer without notice.

23 Warranty

JENN-AIR COOKING APPLIANCE WARRANTY

Full One Year Warranty - Parts and Labor

For one (1) year from the original retail purchase date, any part which fails in normal home use will be repaired or replaced free of charge.

Limited Warranties - Parts Only

Second Year - After the first year from the original purchase date, parts which fail in normal home use will be repaired or replaced free of charge for the part itself, with the owner paying all other costs, including labor, mileage and transportation.

Third Through Fifth Year - From the original purchase date, parts listed below which fail in normal home use will be repaired or replaced free of charge for the part itself, with the owner paying all other costs, including labor, mileage and transportation.

- **Electronic Controls**
- **Electric Heating Elements:** surface, broil and bake elements on electric cooking appliances.

Canadian Residents

The above warranties only cover an appliance installed in Canada that has been certified or listed by appropriate test agencies for compliance to a National Standard of Canada unless the appliance was brought into Canada due to transfer of residence from the United States to Canada.

Limited Warranty Outside the United States and Canada - Parts Only

For two (2) years from the date of original retail purchase, any part which fails in normal home use will be repaired or replaced free of charge for the part itself, with the owner paying all other costs, including labor, mileage and transportation.

The specific warranties expressed above are the ONLY warranties provided by the manufacturer. These warranties give you specific legal rights, and you may also have other rights which vary from state to state.

What is Not Covered By These Warranties:

1. Conditions and damages resulting from any of the following:
 - a. Improper installation, delivery, or maintenance.
 - b. Any repair, modification, alteration, or adjustment not authorized by the manufacturer or an authorized servicer.
 - c. Misuse, abuse, accidents, or unreasonable use.
 - d. Incorrect electric current, voltage, or supply.
 - e. Improper setting of any control.
2. Warranties are void if the original serial numbers have been removed, altered, or cannot be readily determined.
3. Light bulbs.
4. Products purchased for commercial or industrial use.
5. The cost of service or service call to:
 - a. Correct installation errors.
 - b. Instruct the user on the proper use of the product.
 - c. Transport the appliance to the servicer.
6. Consequential or incidental damages sustained by any person as a result of any breach of these warranties.

Some states do not allow the exclusion or limitation of consequential or incidental damages, so the above exclusion may not apply.



403 WEST FOURTH STREET NORTH • PO BOX 39 • NEWTON, IA 50208